

# Размер (рост) 158

Соответствие размеров  
смотрите на сайте  
«Шкатулка»

<https://shkatulka-sew.ru>

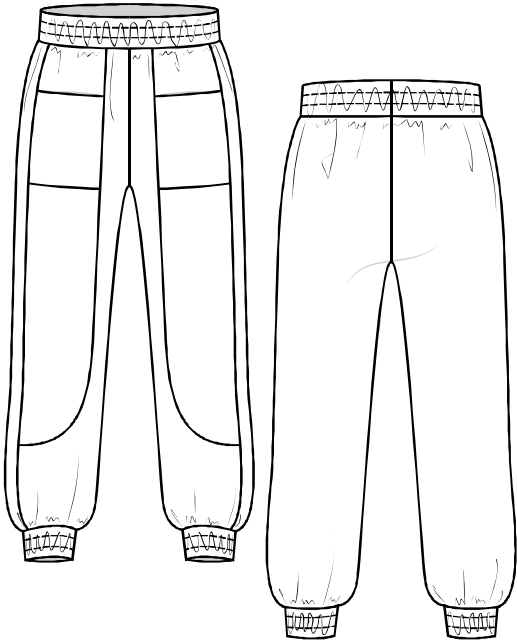

Файл с выкройкой и все его фрагменты охраняются  
**законом об авторском праве**. Публикация и распространение  
выкройки и ее фрагментов запрещены!

Официальное разрешение предоставлено только следующим  
сайтам:

<https://shkatulka-sew.ru>

Если Вы обнаружили нарушение авторских прав,  
необходимо сообщить об этом по адресу [admin@shkatulka-sew.ru](mailto:admin@shkatulka-sew.ru)

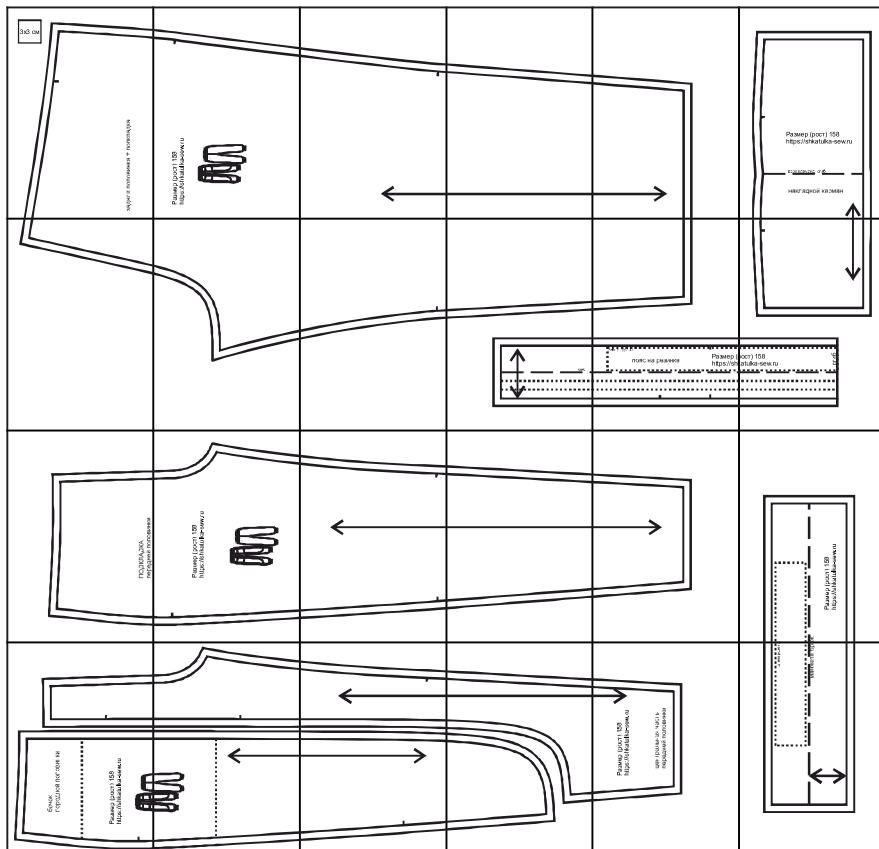

Выкройку нужно распечатывать только через  
программу Adobe Reader с масштабом «реальный размер»

3x3 cm

01-01

задняя половинка + подкладка



Размер (рост) 158  
<https://shkatulka-sew.ru>

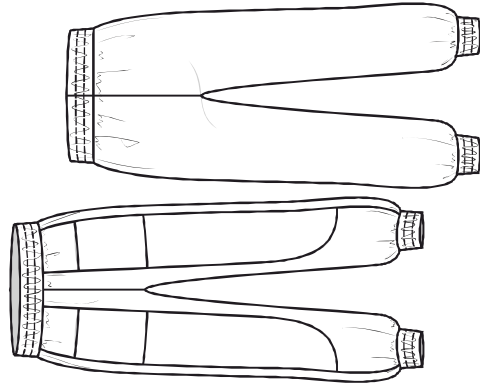

01-02



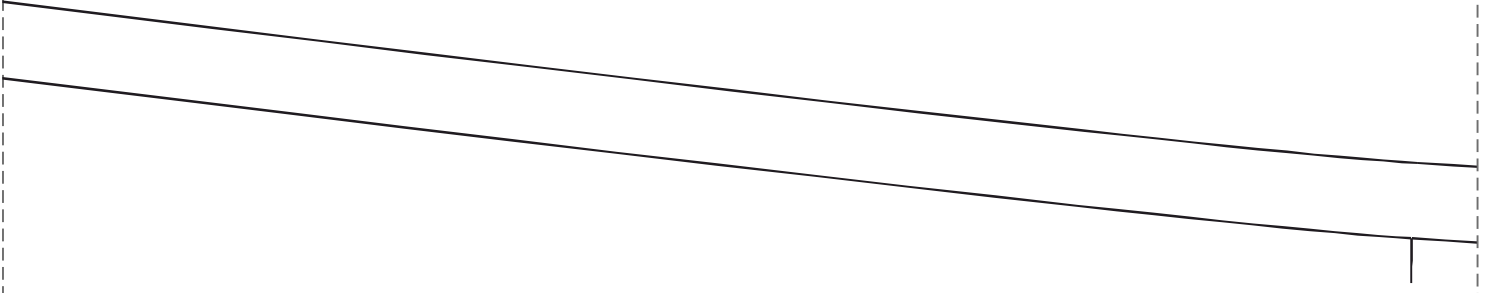

**01-03**





**01-04**





**01-05**

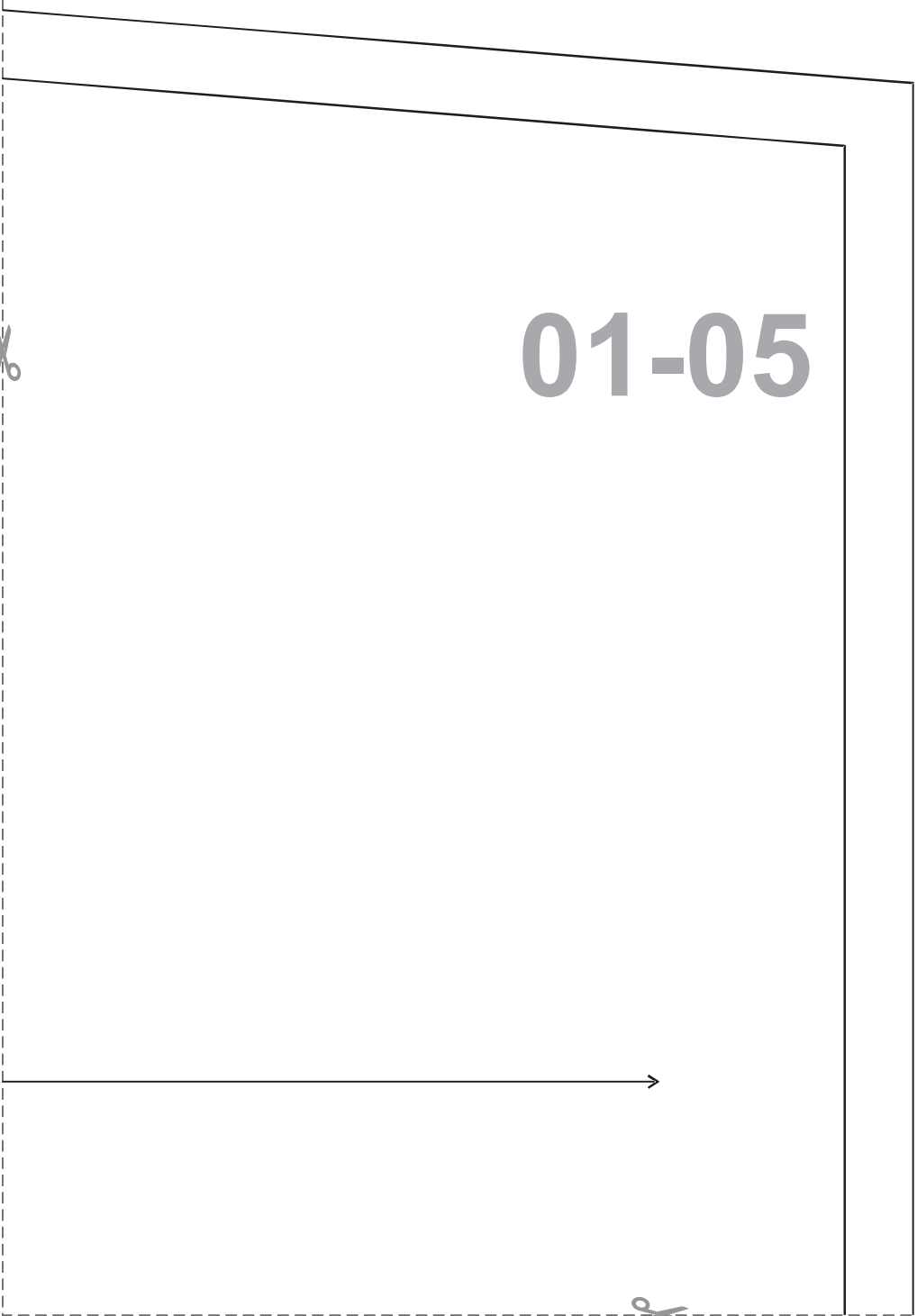



**01-06**

Размер (рост) 158  
<https://shkatulka-sew.ru>

верх кармана, сгиб



накладной карман



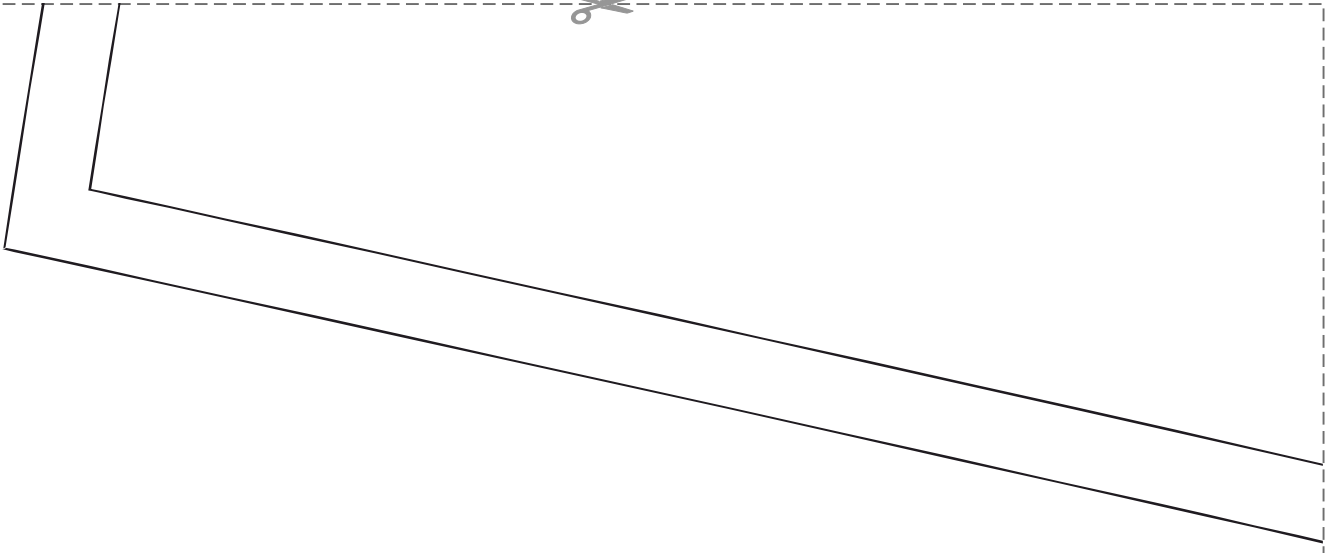

**02-01**





02-02





02-03





02-04

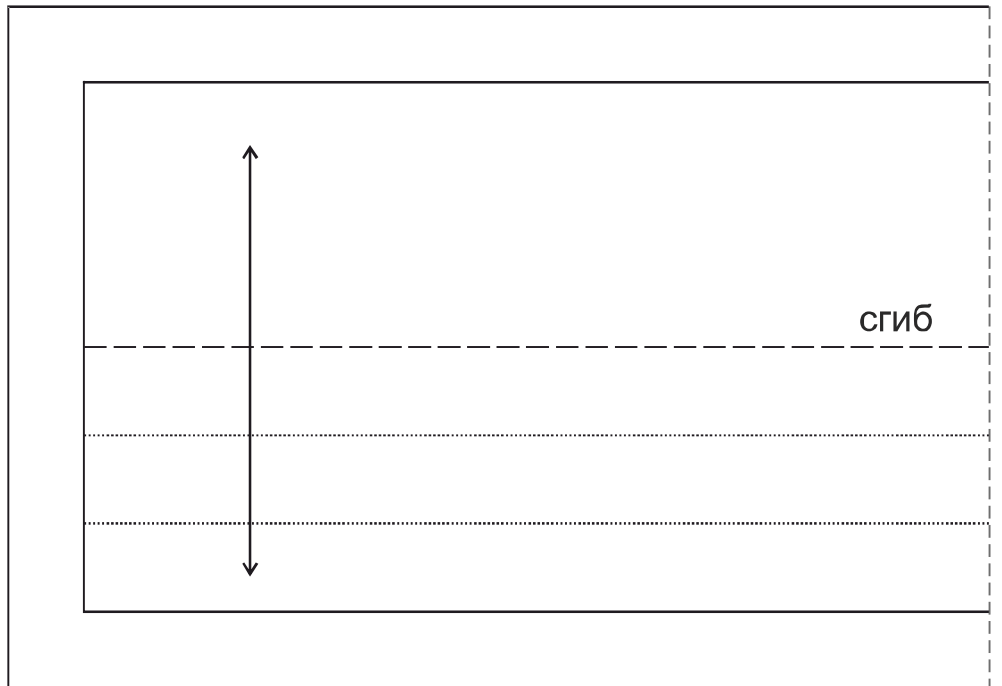

сгиб





02-05



длина резинки

пояс на резинке

Размер (  
<https://sh>



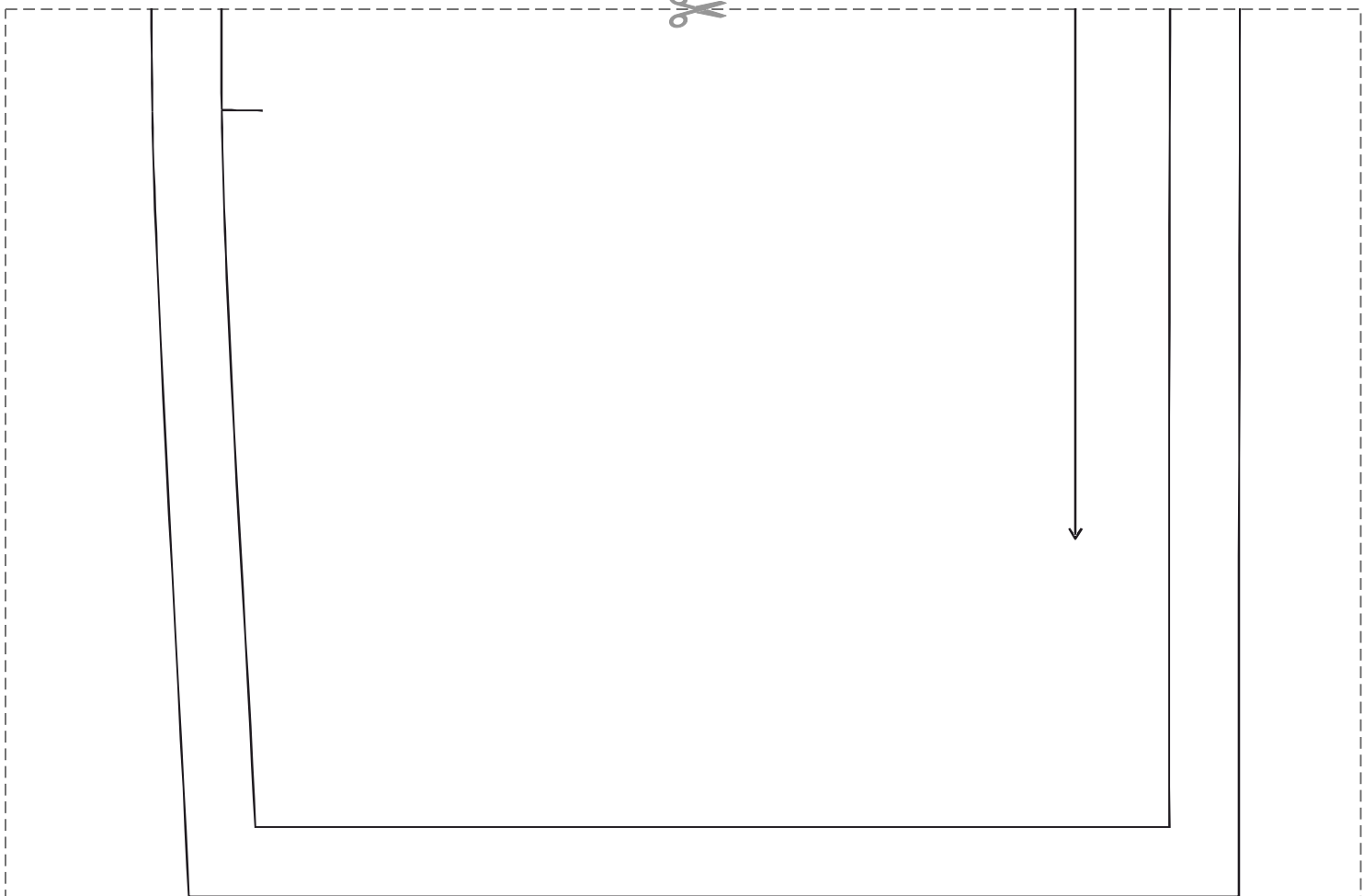

02-06





**03-01**

**ПОДКЛАДКА  
передней половинки**



Размер (рост) 158  
<https://shkatulka-sew.ru>

03-02

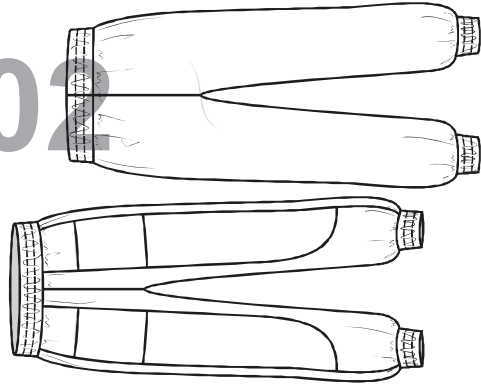

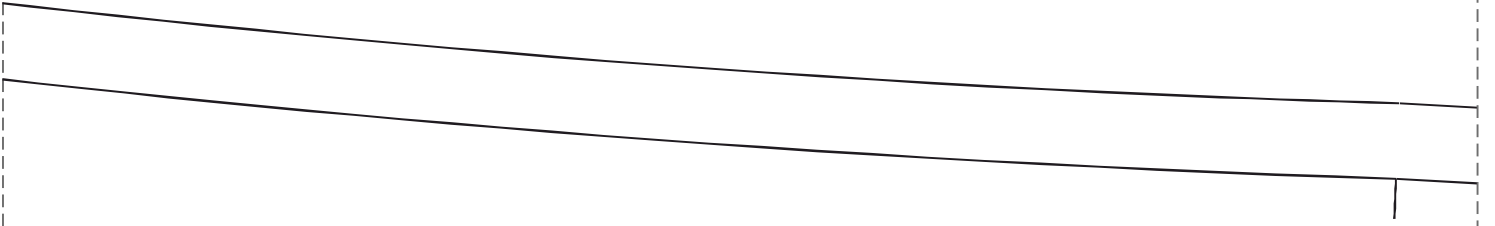

**03-03**

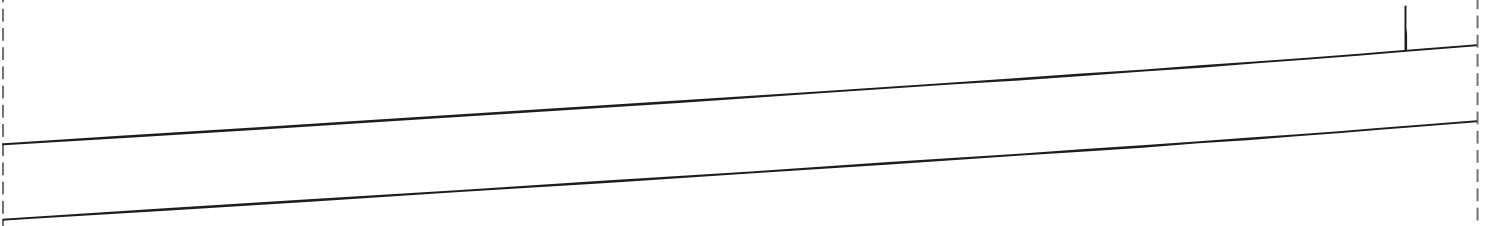



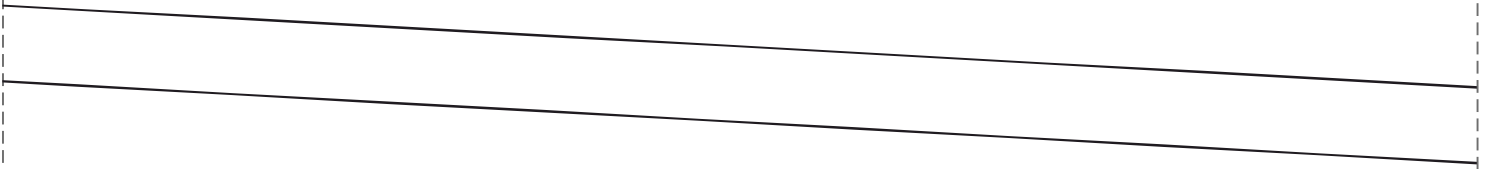

**03-04**

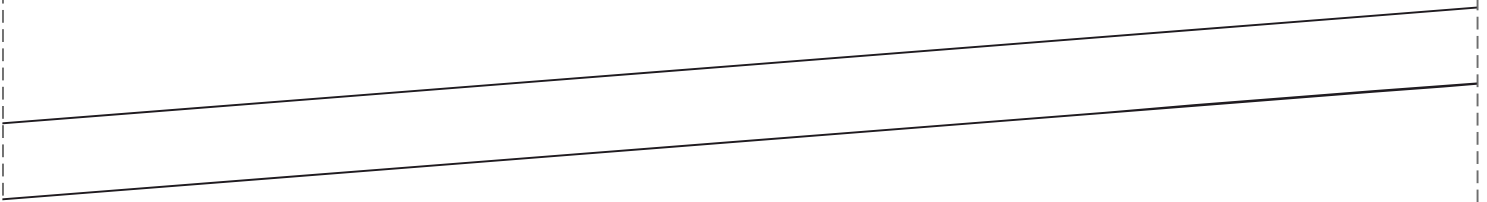

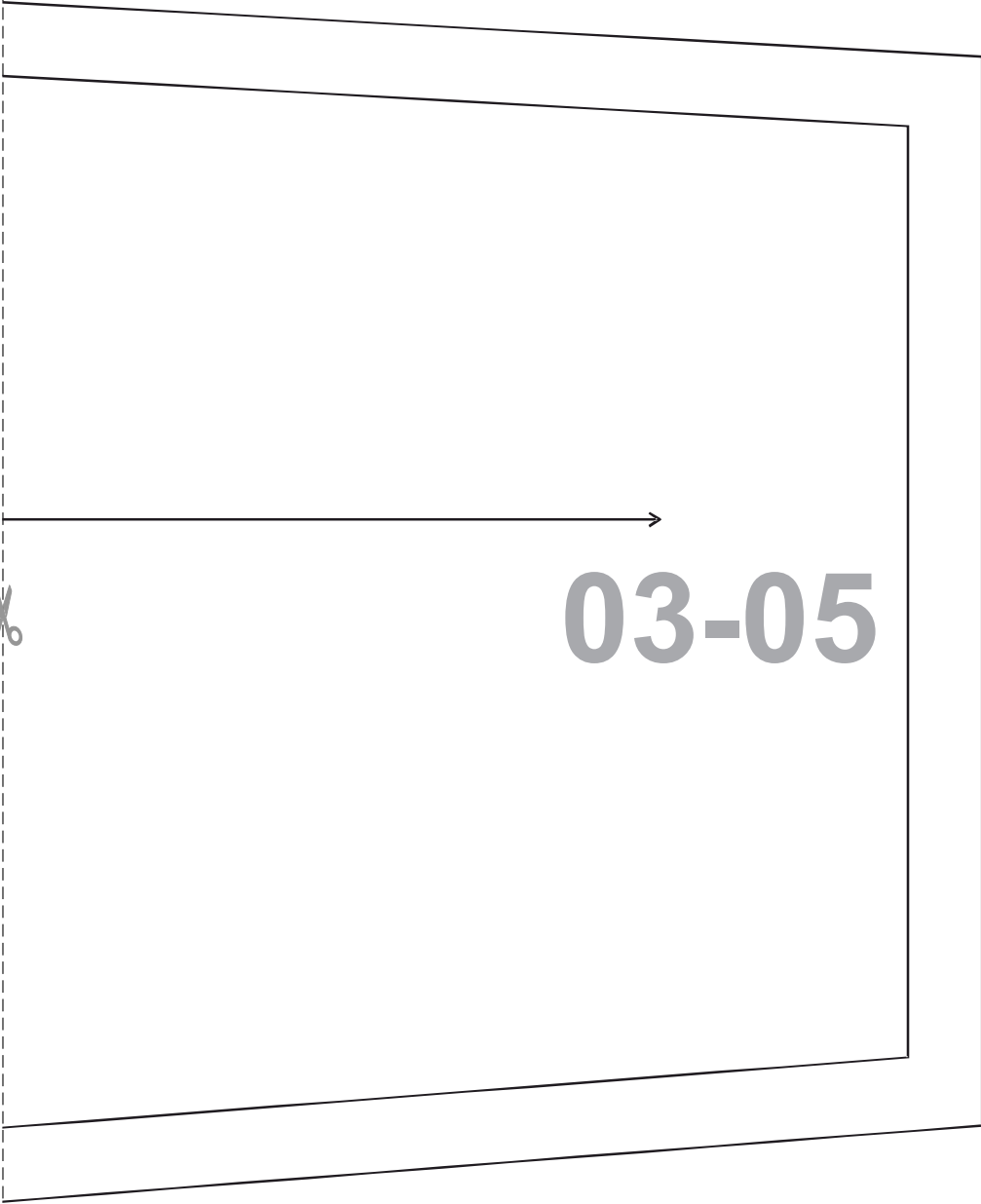

**03-05**



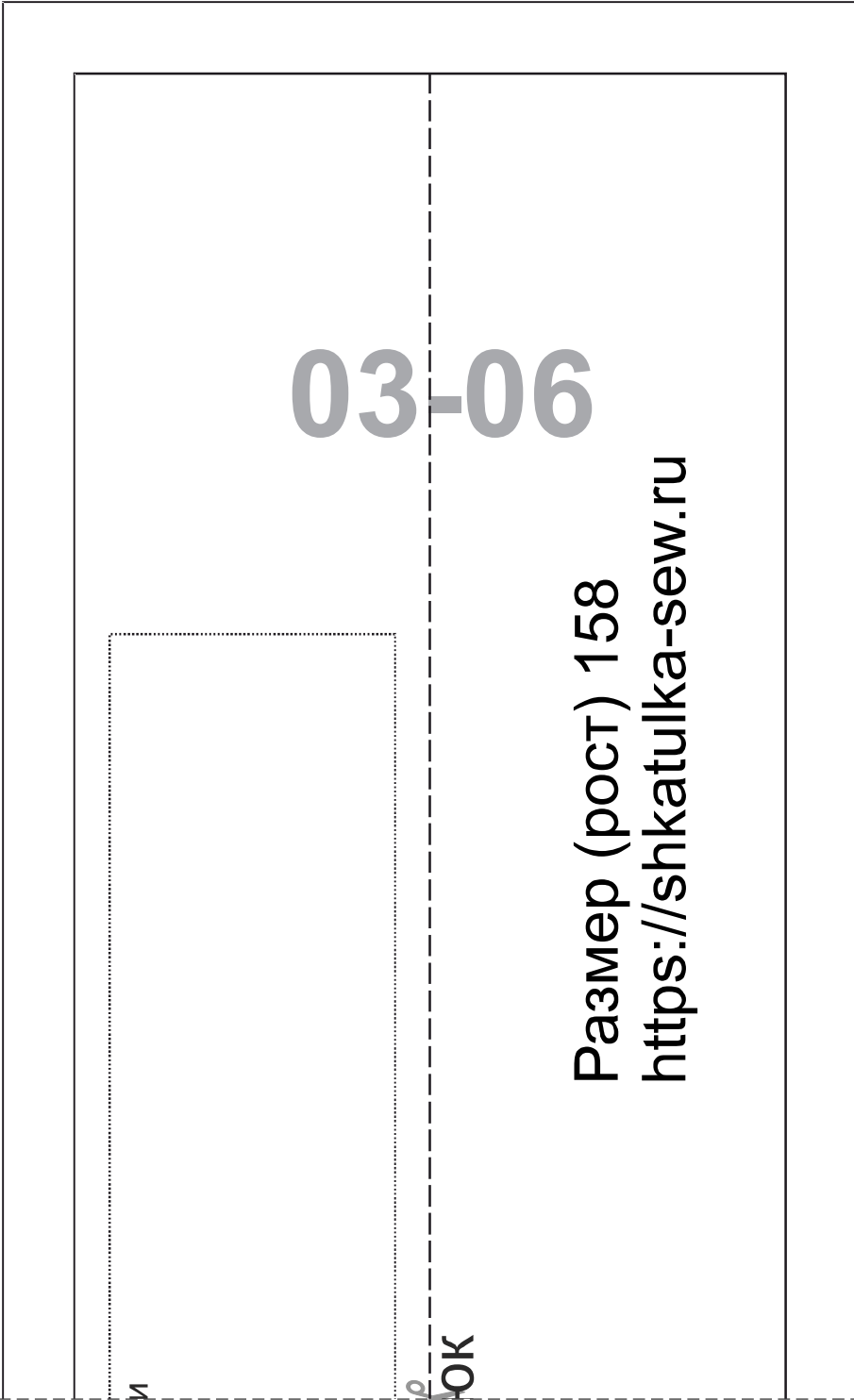

03-06

Размер (почт) 158  
<https://shkatulka-sew.ru>

и

OK

бочок  
передней половинки

04-01

Размер (рост) 158  
<https://shkatulka-sew.ru>

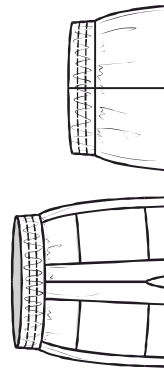

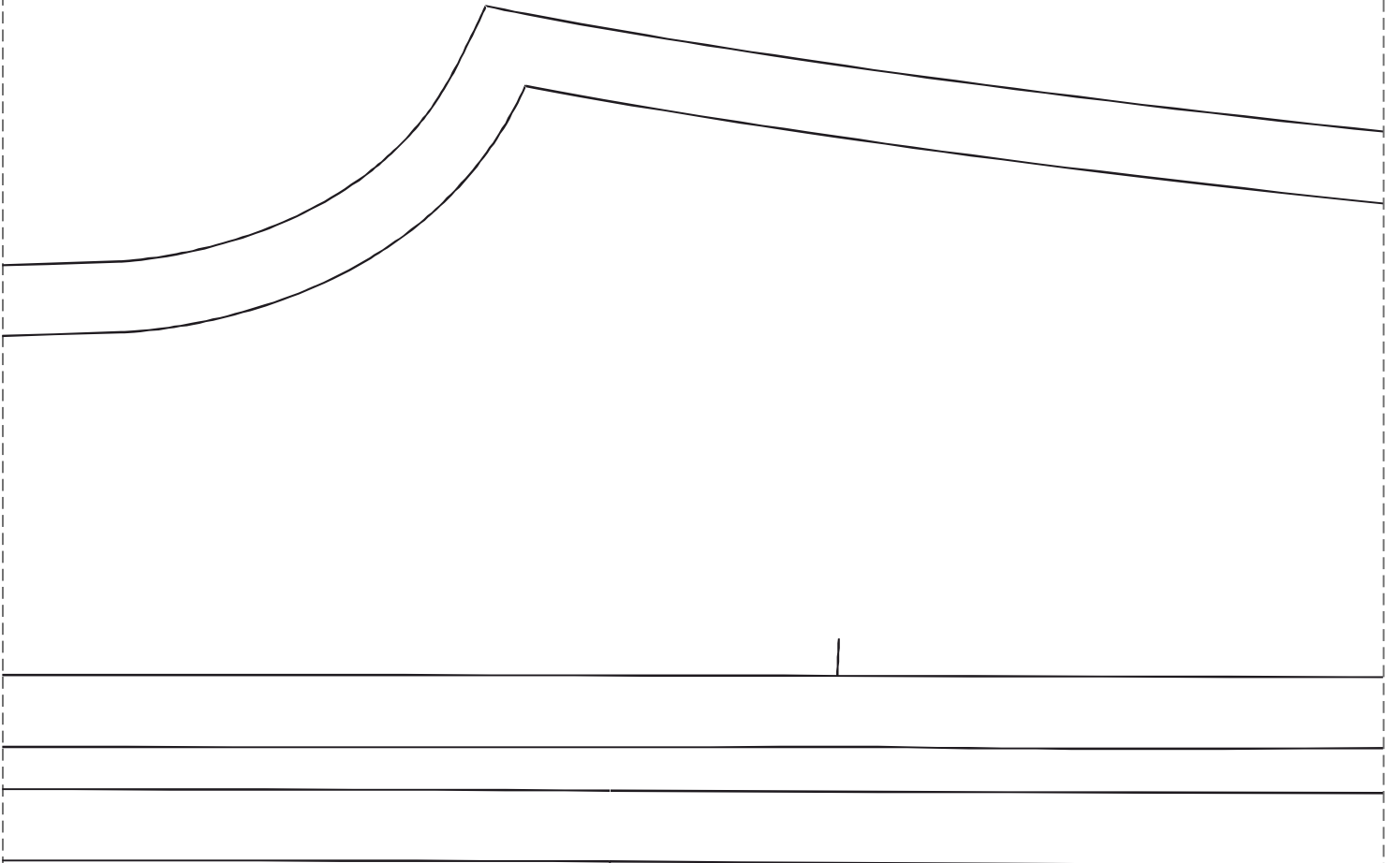

04-02

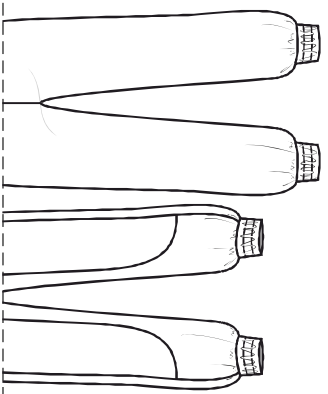



04-03



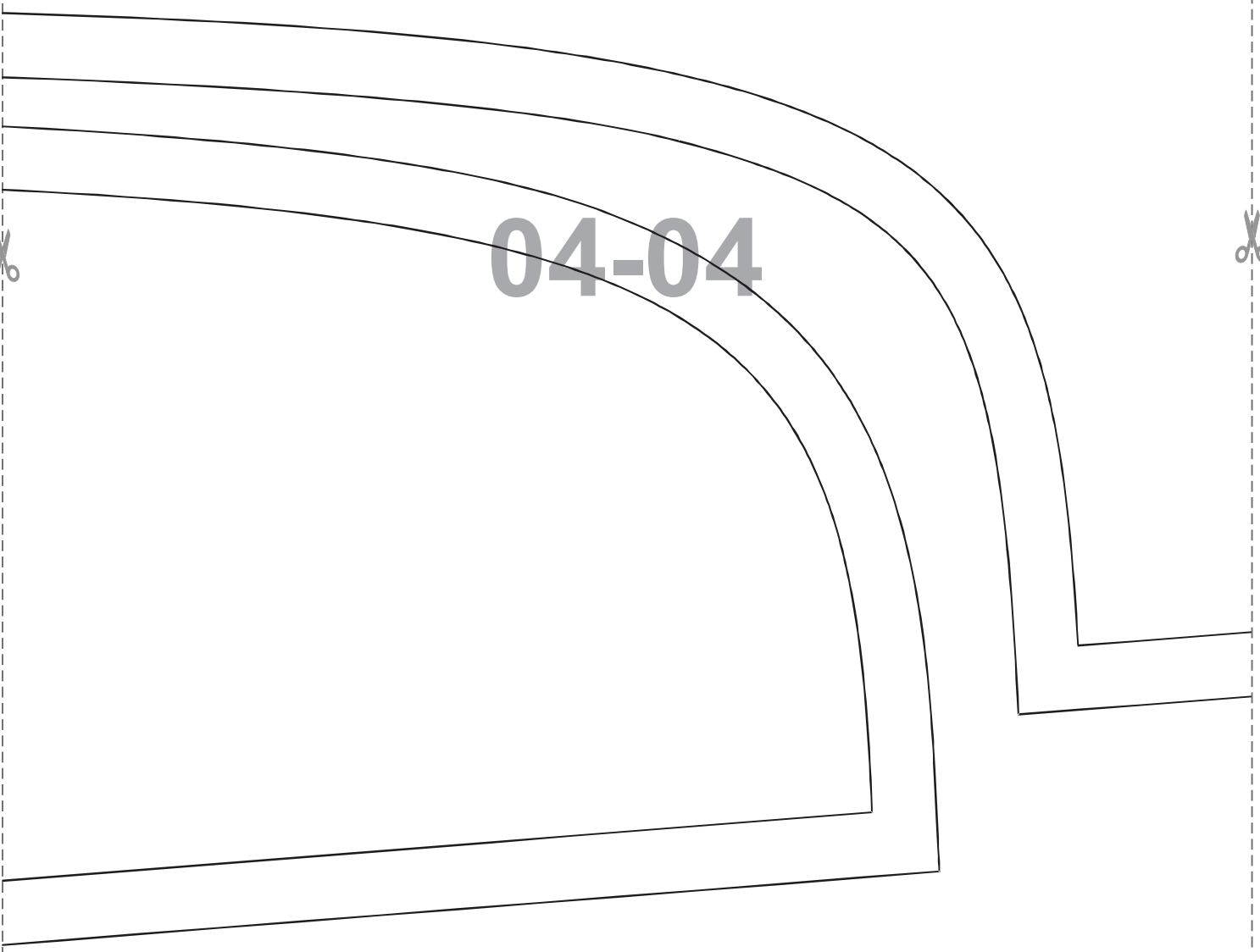
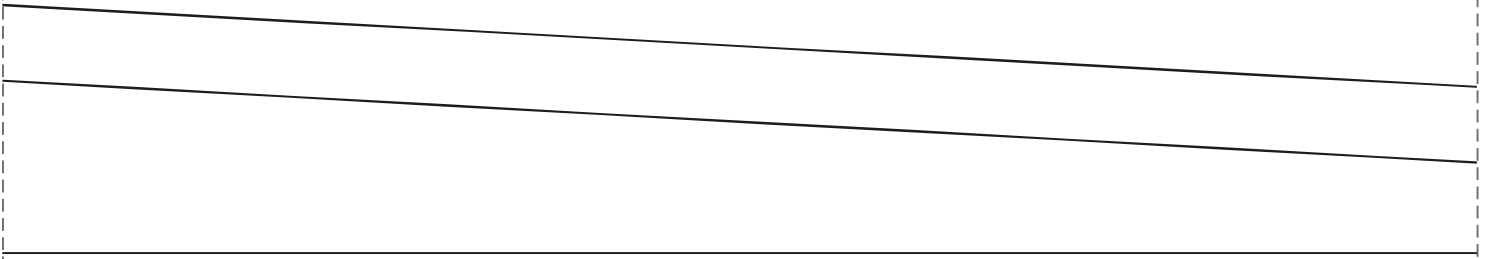

04-04



Размер (рост) 158  
<https://shkatulka-sew.ru>

0405  
центральная часть  
передней половинки







длина резинк

манжета бр<sup>о</sup>

04-06

